

# RFID-Based Students Attendance Management System

Arulogun O. T., Olatunbosun, A., Fakolujo O. A., and Olaniyi, O. M.

**Abstract** In recent years, there have been rise in the number of applications based on Radio Frequency Identification (RFID) systems and have been successfully applied to different areas as diverse as transportation, health-care, agriculture, and hospitality industry to name a few. RFID technology facilitates automatic wireless identification using electronic passive and active tags with suitable readers. In this paper, an attempt is made to solve recurrent lecture attendance monitoring problem in developing countries using RFID technology. The application of RFID to student attendance monitoring as developed and deployed in this study is capable of eliminating time wasted during manual collection of attendance and an opportunity for the educational administrators to capture face-to-face classroom statistics for allocation of appropriate attendance scores and for further managerial decisions.

**Keywords:** RFID, Lecture, Attendance, Passive tag, Reader

## INTRODUCTION

The emergence of electronic paradigm for learning compared to traditional method and availability of almost all information on the information superhighway(Internet), nowadays have caused students to be less motivated to come to the lecture rooms than ever before. Laziness on the part of students, nonchalance to school work, extra social activities that have no importance in aiding the objectives of the institution and a lot more, may prevent students from attending lectures. Sequel to these, lecturers and administrators in most developing countries have had to come up with ways to ensure a healthy participation from students, and make sure that the student-lecturer interactive relationship is kept intact. This in some cases have come in simple forms like roll calls, while in more interesting cases, can be formats like surprise quizzes, extra credit in class, etc. These strategies are however time consuming, stressful and laborious because the valuable lecture time that could otherwise been used for lectures is dedicated to student attendance taking [8] and sometimes not accurate.

In addition to all these challenges, the attendances are recorded manually by the tutor and therefore are prone to personal errors. There arises a need for

a more efficient and effective method of solving this problem. A technology that can solve this problem and even do more is the RFID technology. RFID is an automated identification and data collection technology, that ensures more accurate and timely data entry. RFID is not actually a new technology; it only quickly gained more attention recently because of its current low cost and advances in other computing fields that open up more application areas. RFID combines radio frequency and microchip technologies to create a smart system that can be used to identify, monitor, secure and do object inventory. At their simplest, RFID systems use tiny chips called —tags that contain and transmit some piece of identifying information to an RFID reader, a device that in turn can interface with computers [7]. The ability of RFID systems to deliver precise and accurate data about tagged items will improve efficiency and bring other benefits to business community and consumers alike in the not distant future [11]. In this paper, we present an intelligent RFID based lecture attendance access control and management system tailored around Nigerian Universities' Commission (NUC) policy of ensuring a 70% course attendance by students for a course before likelihood of writing a semester examination for any course. The application of RFID Technology to student course attendance monitoring problem especially in developing countries in our proposition will lead to elimination or reduction of the quality time wasted during manual collection of attendance, creation of a student database management system that is not

Arulogun is currently in the Department of Computer Science and Engineering Ladoke Akintola University of Technology, Ogbomoso, Nigeria, E-mail: [lotarulogun@autech.edu.ng](mailto:lotarulogun@autech.edu.ng)  
Olatunbosun and Fakolujo are currently in the Electrical and Electronic Engineering Department, University of Ibadan, Nigeria.,  
Olaniyi is currently in the Department of Computer Engineering, Federal University of Technology, Minna, Nigeria. E-mail: [mikail.olaniyi@futminna.edu.ng](mailto:mikail.olaniyi@futminna.edu.ng)

prone to errors or being manipulated by anyone and above all aids in better management of classroom statistics for allocation of attendance

## REVIEW OF RELATED WORKS

A number of related works exist in literature, application of RFID Technology to different areas and specifically to the area of academic attendance monitoring problem. In [6], authors designed and implemented a model of a secured and portable embedded reader system to read the biometric data from the electronic passport. The authors attempted to solve problems of reliability, security and privacy in E-passports by authenticating holder online using Global System of Mobile Communications (GSM) network. The GSM network is the main interface between identification centre and the e-passport reader. The communication data is protected between server and e-passport reader by using AES to encrypt data for protection while transferring through GSM network. Author in [5] reviewed the current research application of RFID to different areas with emphasis on application for supply chain management and developed a taxonomic framework to classify literature which enables swift and easy content analysis to help identify areas for future research. Authors in [9] reviewed the use of RFID in an integrated-circuit(IC) packaging house to resolve inventory transaction issues. His study suggests that RFID contributes significant improvements to the water receiving process and the inventory transaction process that reduce labour cost and man-made errors. In [10], an automated attendance management system was implemented both in electronic and mobile platform using stationary matrix AR 400 RFID reader with four circulatory polarized antennae and Symbol MC9000-G handheld RFID reader respectively. In the electronic platform, the attendance management system

## MATERIALS AND METHOD

The primary purpose of an RFID system in this application area is to detect the presence and absence of the student data to be transmitted wirelessly by mobile device, called a tag, which is read by an RFID reader and processed according to the programmed instructions on the personal computer (PC). The ease with which RFID can be integrated into current operations depends on the

scores in the final grading of student performance in a particular course.

depicts a simple client (antennae placed at classroom entrance) /server (privileged student database) system. Students can visually see their names as they entered class on the screen and they are assured that their presence has been entered in the instructor's database. However, one important drawback about this system is the RFID tag read rates degrade tremendously as it comes closer to electronic devices.

In [1], an automatic attendance system using fingerprint verification technique was proposed. The fingerprint technique verification was achieved using extraction of abnormal point on the ridge of user's fingerprint or minutiae technique. The verification confirms the authenticity of an authorized user by performing one to one comparison of a captured fingerprint templates against the stored templates in the database. The proposed automatic attendance system signals either true or false based on logical result of previous one to one verification of person's authenticity [2]. Authors in [3] also reviewed and proposed biometric system using fingerprint identification for attendance automation of employees in an organization. Consequently, authors in [4] proposed student wolf pack club tracking system to simplify and speed up the process of student wolf pack club ticket distribution for athletic event. Our proposition emphasizes a simple, reliable and cost effective model for face-face classrooms' attendance management that uses existing student ID card chip as the passive tag with additional short message services to parents as weekly summary.

openness and flexibility of the technology infrastructure especially the PC that will be used to collect and collate RFID data. The proposed system provides solution to lecture attendance problem through coordinated hardware and software design handshaking data communications between RFID tag and RFID reader serially interfaced to the digital computer system. The Intelligent RFID based

students attendance management system from Fig. 1 was designed around Intersoft RFID DemoKit-1. The developed attendance management system in this work abides by the following hardware and design considerations described as follows.

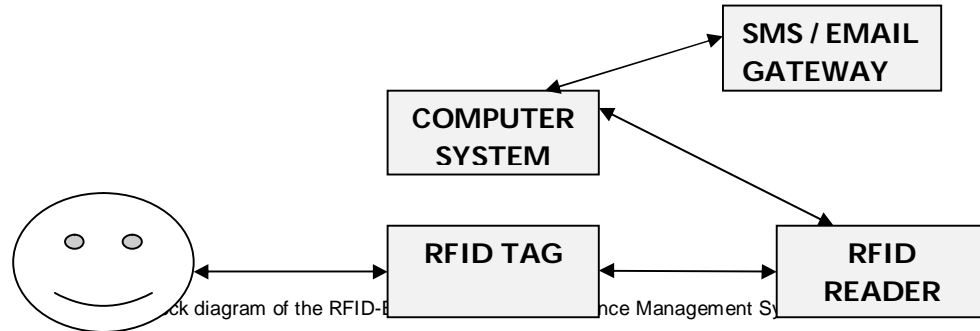

### Hardware Design Considerations

In RFID systems, an item is tagged with a tiny silicon chip plus an antenna collectively called a tag. The tag can be mobile or stationary and be scanned by stationary or mobile readers respectively, using radio waves. The tag can be encoded with a unique identifier, allowing tagged items to be individually identified by the reader. In each scanning case, a reader must scan the tag for the data it contains and then send that information to a database, which interprets the data stored on the tag. The tag, reader, and database are the key components of an RFID system. The proposed RFID system offer many advantages to this design application because electronic tags can be embedded into student conventional means of identification (student ID card); the electronic tag can be read during motion; no batteries are needed; no line of sight required for

wireless communication between the tag and the reader; Tags are almost indestructible, can be read even if covered with dirt or submerged and tags have unalterable permanent serial code that prevents tampering.

The RFID system was designed around Intersoft RFID DemoKit-1 proprietary RFID system serially interfaced to the PC. The Kit contains the following components: The kit RFID Reader (Gray Box with RS232 – Female DB9 Interface) which incorporates a TR-R01-OEM reader board and antenna; RFID Tags/Transponders; 9V DC Battery; Battery Adapter – plugs the 9V DC battery to the reader; RS232 (Male DB9) to USB connector cable as shown in Fig. 2:

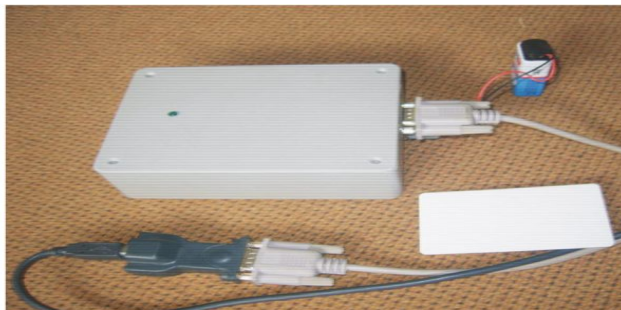

Fig. 2. Intersoft RFID Demo Kit Setup

The TR-R01-OEM reader board performs all the functions necessary for the RFID reading station. It continuously reads and decodes transponders that are within its reading range. When a transponder

tag passes within range of the reader antenna, the RF magnetic field generated by the reader powers the tag. The data is then sent as a packet using a two wire RS232 (or TTL) interface. While the tag

remains within reading range, it will be continuously powered and the reader will continuously transmit its data. The reader has two connectors: A female DB9, and a 2.1mm DC Jack shown in Fig. 3. The female DB9 provides the RS232 serial output from the reader. Pin 2 is the transmit signal output (TXD). It is connected to receive (RXD) signal input of the computer via the DB9 to USB interface cable. Pin 5 is the common ground

reference signal and is connected to the common ground of the computer via the DB9 to USB interface cable. The DC power jack is used to power the reader. The centre pin of the jack is connected to the positive side of a 9-12V DC power supply. The outer conductor is connected to the negative side of the power supply (9V DC battery).

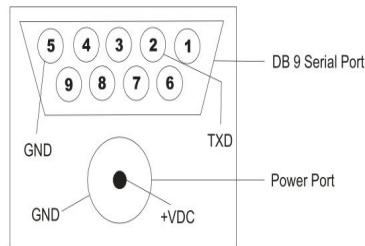

Fig. 3. Front view of the RFID reader's connector ports

A single antenna is required for powering and reading the passive transponders (tags). The antenna is used in series resonant circuit, formed by capacitor, inductor and resistor. The antenna is a square antenna 9cm X 9cm with 83 turns, inductance of 1.58mH with 10 ohm resistance. The reading range is spherical with the antenna located at the equator. Minimum and maximum read range is determined by the surface area of the tag. The system was set up as shown in figure 4.0 with the following steps:

- a. Connecting the Male head of the RS232 serial cable to the Female DB9 port of the RFID reader.
- e. .

- b. Connecting the USB end of the serial cable to one of the USB ports of the computer system being used.
- c. Connecting the 9V dc battery to the Adapter and then the adapter to the RFID reader's power jack.
- d. Determination of the appropriate COM port of the computer used, and ensure that it corresponds to the one used within the programming code written to control the system

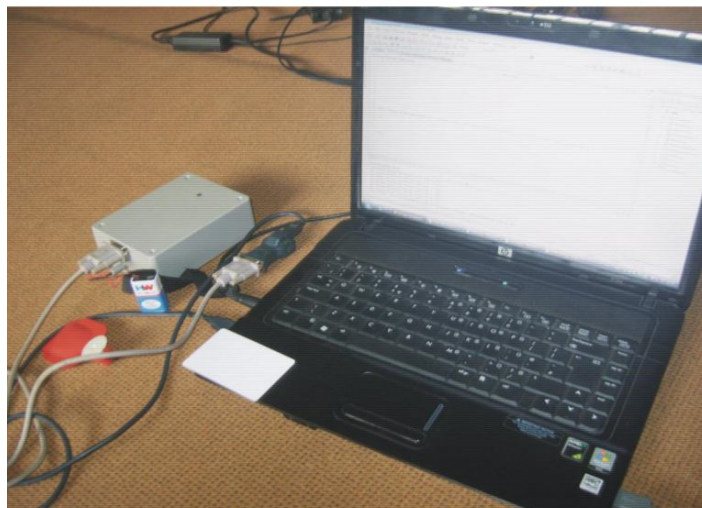

Fig.4. RFID Student Attendance Management System Setup

### Software Design Considerations

In the development cycle of the system, decisions were made on the parts of the system to be realized in the hardware design and the parts to be implemented in software. The software is decomposed into modules so that each module can be individually tested as a unit and debugged before the modules are integrated and tested as a software system in order to ensure that the software design meets its specification.

The program was written in Microsoft Visual C# programming language for the front end while the backend was based on Microsoft SQL Server relational database management system

(RDBMS). Visual C# was derived from C language and C++ and enables the rapid application development (RAD) of graphical user interface (GUI) applications, access to databases using tools such as DAO, RDO, ADO, and the creation of ActiveX controls and objects. Programming in Visual C# provides the user with the ability to utilize a combination of visually arranged components or controls on a form, specifying attributes and actions of those components, and writing additional lines of code for more functionality. The software was designed using the flowchart shown in Fig. 5:

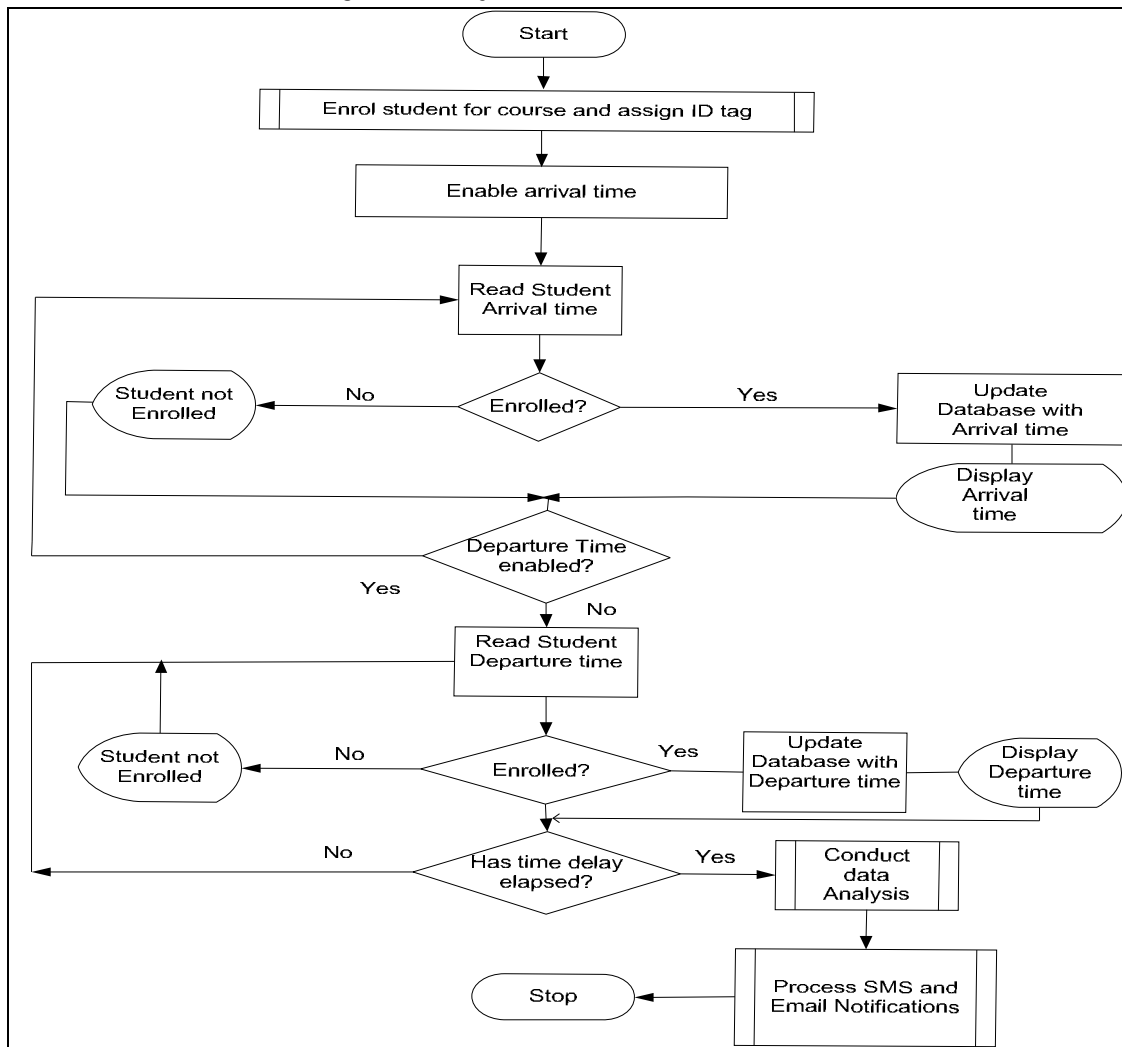

Fig. 5. Flowchart showing the mode of operation of the student attendance RFID system.

## SYSTEM OPERATION, TESTING AND DISCUSSION

A careful observation of the trend of usage of RFID tags leads one to consider the possibility of its utilization for monitoring the attendance of students in educational institutions, with the aid of program driven computers. While every student given a specific RFID tag attends the lecture through entrance door, a serial number (related to each student's matriculation number) of tag is associated with the student database entry. So every time a student uses his/her card, the entries will be entered into the database with the time stamp. The use of webcam might be optionally necessary to

take a snap of the person using the card. Webcam reduces proxy attendance attempts. This is used to cross-verify in the event of an undesirable event or dispute. Consequently, the attendance data then can be used to create many types of reports like daily attendance details, monthly, weekly and real time feedback to parents. The attendance score calculation can be automated using the collected data. After setting up the student attendance RFID system from the mode of operation depicted in the diagram shown in figure 6.0:

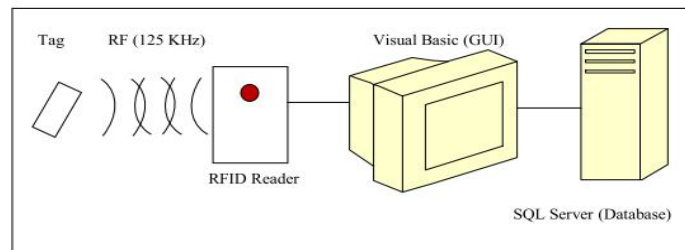

Fig. 6. Illustration of the RFID system operational principle.

The tag is activated when it passes through a radio frequency (RF) field (125 kHz in this case), which is generated by the antenna embedded within the reader box. The program checks whether the tag is valid or not. If the tag is valid, it will continue to the database program and registers the student's attendance for the course. If the tag is invalid, the program gives a notification that the tag has not been registered to any student and requires the user to either supply a valid tag.

Due to the reason of cost and flexibility of implementation, this RFID attendance design application uses a passive tag and thus for every class, students would have to bring their tags close to the reader (about 10 cm from the reader). On doing this, the reader reads the tag and the application program records the student's arrival time and when leaving the class, students will also have to bring their tags close to the reader again. With records of arrival and exit time, appropriate short message service is forwarded to the parents' mobile phone number in real time or as a weekly sms/email digest through the SMS/EMAIL gateway as shown in Figure 1.0. Each course lecturer has RFID tag that serves as the control for

the beginning and end of classroom lecture with additional time delay for end of class activation to allow every student to record exit time on the reader. The lecturer/instructor can call for information over any student by using queries provided by the application. More flexibility and unconscious interaction of students to the developed system can be achieved by using active tags. This will increase the overall cost of the system.

At the end of the semester, the lecturer can grade students attendance scores in a particular course based on some specific metrics provided in the application. The selected metrics could be frequency of presence in class, duration of stay in class, punctuality, etc. The program gives the following output: student name, Matriculation number, tag ID number, department, the course in question and the attendance status based on the specified metrics. A privileged user can de-assign students from their specific tag, and reassign the tag to other students if need be as shown in the Graphical User Interfaces (GUI's) of the RFID system application control program shown in Fig. 7.0-11.0



Fig. 5. Home page

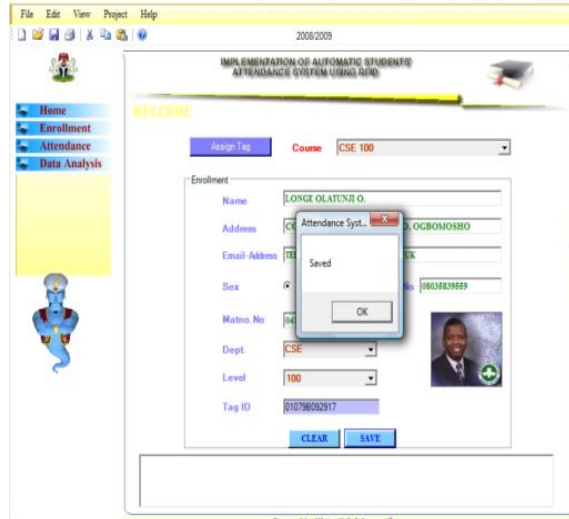

Fig. 6. Enrolment Interface

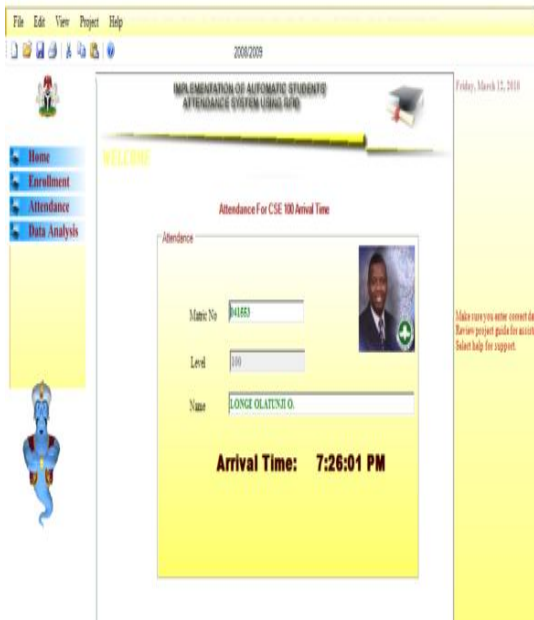

Fig. 7. Attendance

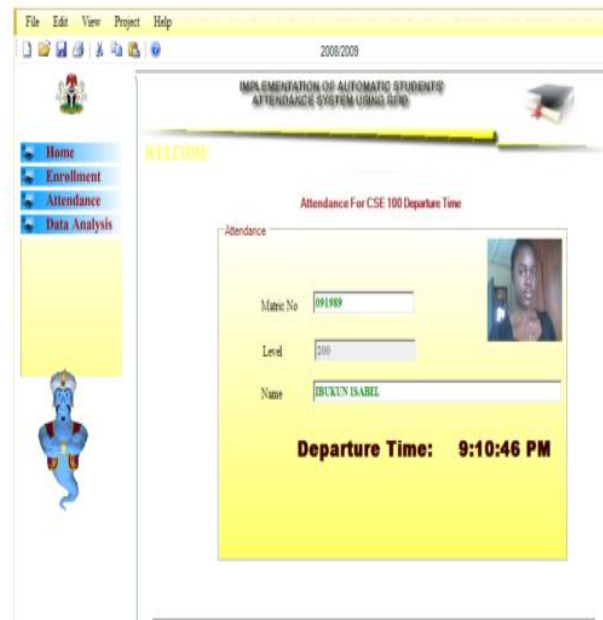

Fig. 6. Departure

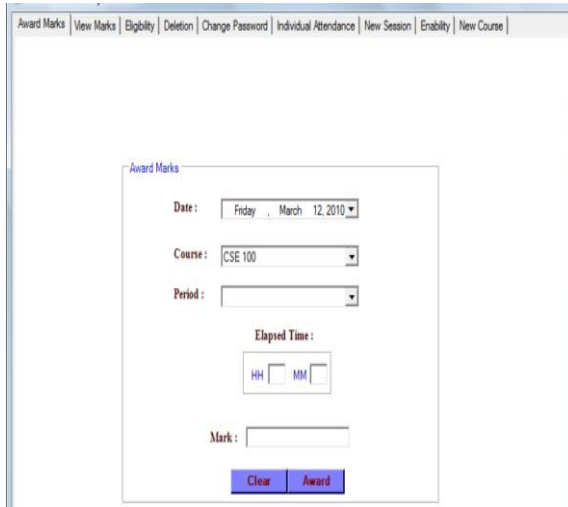

Fig. 8. Awarding class attendance marks

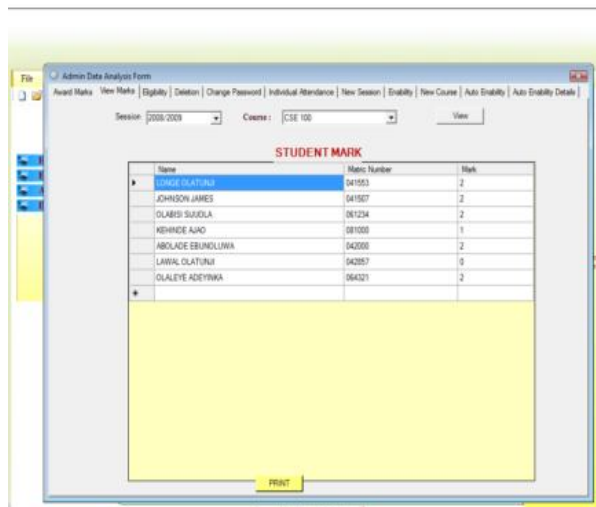

Fig. 9. List of student marks

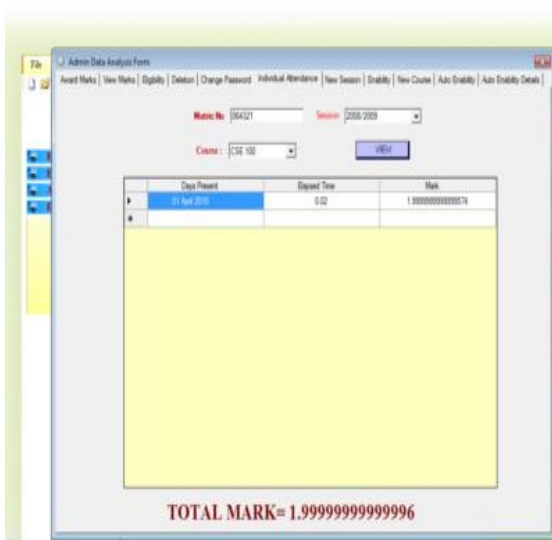

Fig. 10. Individual attendance mark

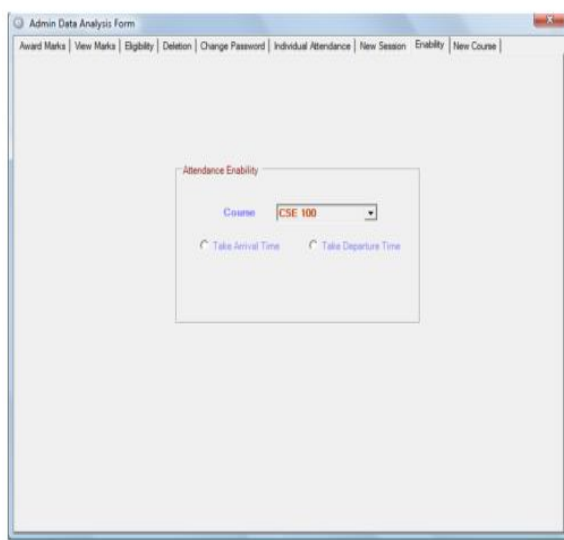

Fig. 11. Attendance enable time

## CONCLUSION

As the RFID technology evolves, more sophisticated applications will use the capability of RFID to receive, store and forward data to a remote sink source. RFID has many applications as can be imagined. In this paper, we have utilized the versatility of RFID in implementing functional and automatic student course attendance recording system that allows students to simply fill their attendance just by swiping or moving their ID cards

over the RFID reader which are located at the entrance of lecture halls with a considerable degree of success and acceptability of usage in our faculty. We hope that this system can shift the paradigm of students' lecture attendance monitoring in face-face classroom and provide a new, accurate, and less cumbersome way of taking student attendance in Nigerian Higher Institutions.

## RECOMMENDATIONS



Every good engineering design innovation has limitations. This passive RFID based lecture attendance monitoring system is not without limitation as a data collection technology with accurate and timely data entry. Hence, the limitation of this design would be improved upon in future by considering the following salient recommendations:

- ✚ By incorporating a facial recognition application that would serve to further increase the biometric security of the system against impersonation by erring students.
- ✚ Usage of High Frequency (HF) active RFID tags against passive Low frequency (LF) RFID tags for better performance and flexibility of users
- ✚ Performance evaluation of combination of thumbprint, facial recognition and RFID technology to students' attendance monitoring problem.

- [9] Liu C.M and Chen L.S (2009), "Applications of RFID technology for improving production efficiency in an Integrated-circuit packaging house," International Journal of Production Research, vol 47, no. 8, pp. 2203-2216,.
- [10] RFIDSensNet Lab (2005), A white paper on Automatic Attendance System. Texas A & M University, Texas, USA.
- [11] Bardaki,C., Kourouthanassis, P. and Pramatar, K., (2012), Deploying RFID-Enabled Services in the Retail Supply Chain: Lessons Learned toward the Internet of Things, Information Systems Management, Vol. 29: no.3, pp. 233-245.

## References

- [1] Chitresh, S and Amit K (2010),"An efficient Automatic Attendance Using Fingerprint Verification Technique ",International Journal on Computer Science and Engineering (IJCSE),Vol. 2 No. 2,pp 264-269.
- [2] Henry. S, S. Arivazhagan and L. Ganesan (2003), "Fingerprint Verification Using Wavelet Transform", International Conference on Computational Intelligence and Multimedia Applications, 2003.
- [3]Maltoni D, D. Maio, A. K. Jain, S. Prabhaker (2003), "Handbook of Fingerprint Recognition", Springer, New York,Pp 13-20.
- [4]Victor S, Jonathan M, Reece J, and Lemire J (2003),"Student Wolfpack Club Tracking System", North Carolina State University. USA. Retrieved by
- [5] Nambiar A.N. (2009)," A supply chain perspective of RFID Systems", World Academy of Science, Engineering and Technology Journal, Volume 6,pp1-5.
- [6] Mohamed A.B, Abdel-Hamid A and Mohammed K.Y.,(2009), "Implementation of an Improved secure system detection for E passport by using EPC RFID tags", World Academy of Science, Engineering and Technology Journal, Volume 6,pp1-5.
- [7] Dawes A.T. (2004),"Is RFID Right for Your Library", Journal of Access Services, Volume 2(4), pp 7-13.
- [8] Longe O.O.(2009),"Implementation of Student Attendance System using RFID Technology", B. Tech Project Report, Ladoke Akintola University of Technology, Ogbomoso, Nigeria.